

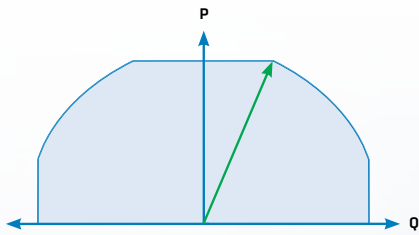

SOLAR MICRO INVERTER 260 COMMUNICATION GATEWAY

Apparent Power Control (APC)



UNIQUE MICRO INVERTER WITH
REAL & **REACTIVE** POWER CONTROL



MAIN ADVANTAGES

- Apparent power control (APC)
- Smart grid ready
- Grid power quality improvement
- Extremely precise MPPT algorithm
- The best overall solar energy conversion
- Compact waterproof design
- Wireless communication
- Very long life-time (25 years)
- Fire safe installations
- Three phase balanced installations with no additional equipment for reactive power compensation
- Integrated interface protection system

APPLICATIONS

Micro, small and medium PV installations (residential, commercial / on-grid, off-grid with storage)

Typical applications

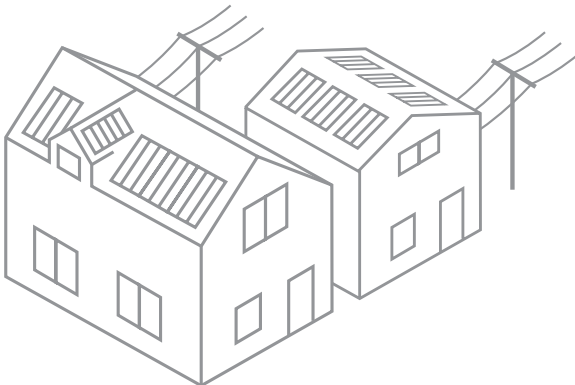

MULTIPLE ORIENTATIONS AND OPTIMAL USE OF ROOF SURFACE

- Modularity
- Each panel MPPT
- Apparent power control

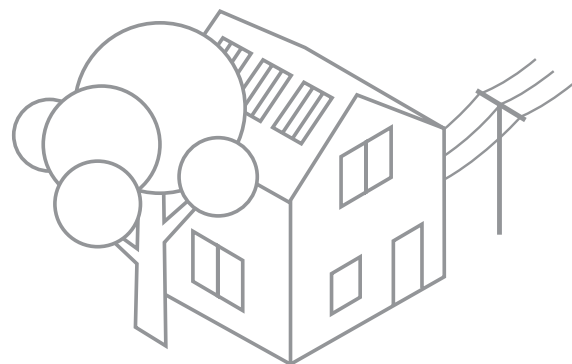

PARTIAL SHADING

- Each panel MPPT
- Extremely precise MPPT

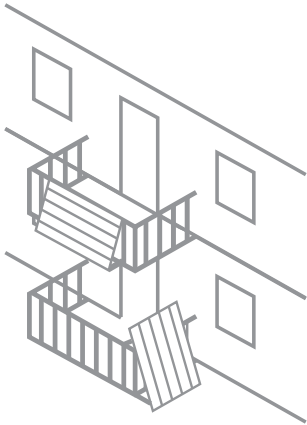

SMALL SPECIFIC SYSTEMS

- Single panel AC grid connection
- Modularity

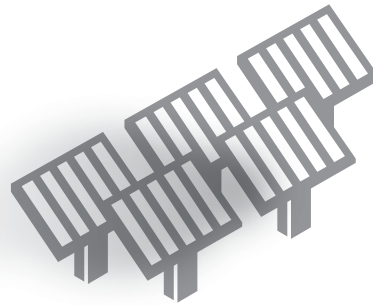

STRING AND MICRO INVERTER COMBINED FIELD APPLICATIONS

- Each panel MPPT
- Extremely precise MPPT

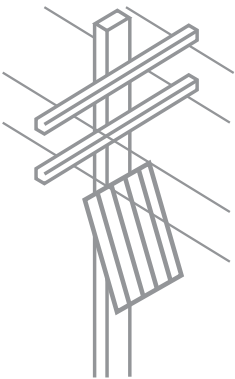

POLE MOUNTED

- Apparent power control
- Grid power quality improvement
- Smart grid ready

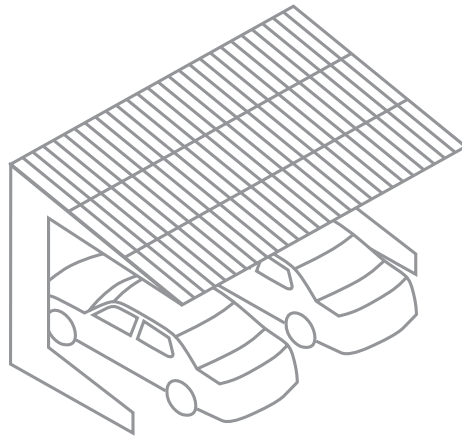

CARPORTS

- AC compact fire safe solutions

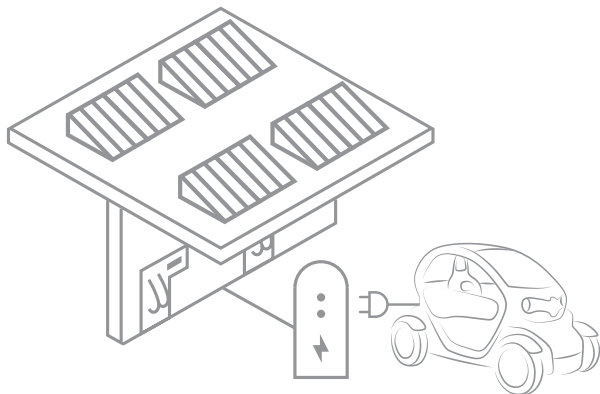

COMBINATION WITH E-MOBILITY

- Smart grid ready
- Fire safe installation

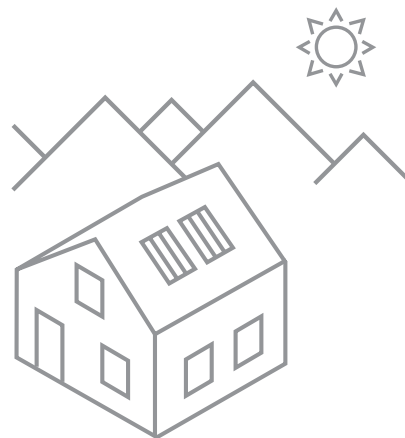

OFF-GRID

- Modularity
- AC battery
- Battery storage



THE MOST EFFICIENT CONVERSION OF LIGHT INTO ELECTRICITY

ADVANTAGES OF MI SYSTEMS

- **The best PV levelized cost of electricity (LCOE) / Total cost of ownership (TCO)** in comparison with power optimizers and string inverters.
- **Up to 20 % higher energy yield** compared to string inverters due to individual panel level shading optimization.
- **No single point of failure.** In case of one inverter's malfunction, the others continue generating energy.
- **Low service cost,** since inverters are simply exchanged in case of failure.
- **Modularly built-up system.** It can be enlarged gradually in time.
- **Wireless monitoring and control.** Each panel's performance can be examined and controlled through standard WMBUS communication.
- **Simple and cost effective installation.** No high DC voltage on roof. Simple 230V AC UL and VDE approved, IP67 rated, UV resistant T connection cables used for inverter interconnections.
- **Safety:**
 - When operating, only a low DC voltage (up to 50V) is present on the roof.
 - In the event of fire and other hazards inverters will switch off in max 2 seconds.
- **Long life-time** without maintenance (25 years).
- Micro-grid suitable technology.
- Suitable for off-grid applications with energy storage.

P - Q diagram

Reactive power generation from 0 to 260 VAR (cap., ind.)

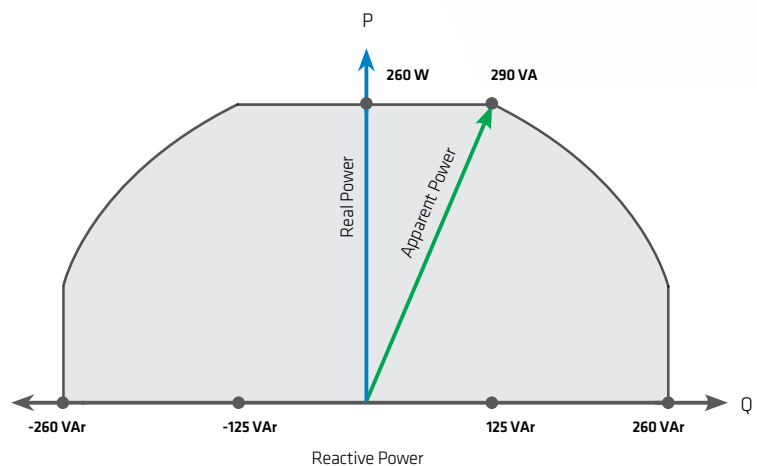

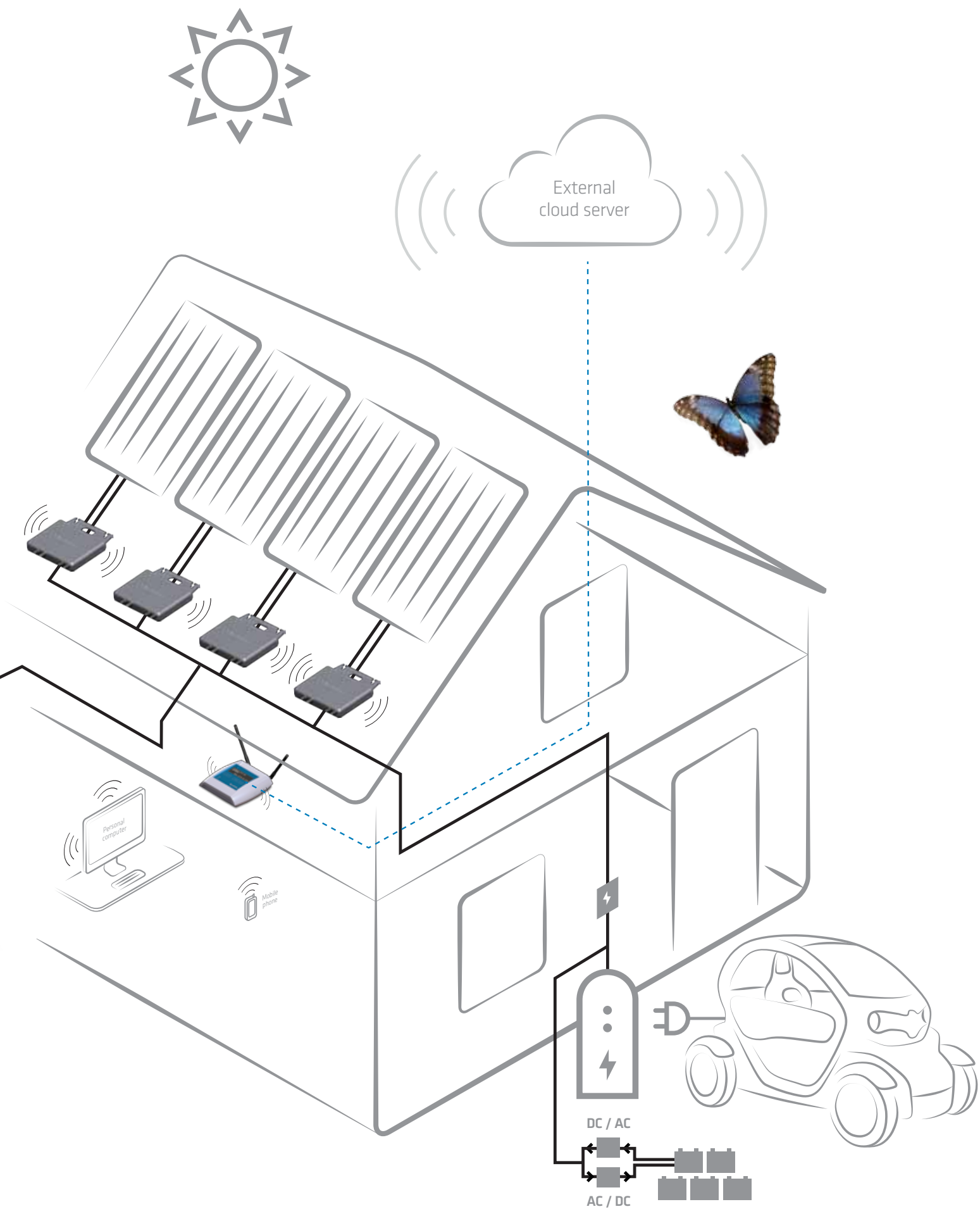

SOLAR MICRO INVERTER 260



FEATURES

- Reactive power control. Dynamic power factor regulation.
- Power factor options:
 - Unity (1),
 - Fixed down to 0.8, capacitive/ inductive,
 - Dynamic according to power or grid voltage.
- Very low power needed to start the inverter (< 2W).
- Foil capacitors are used, allowing very long lifetime (25 years) and high MTBF values (up to 600 years MTBF).
- Electronics is designed with automotive standard components, ensuring easy implementation of automated production with automotive quality and traceability.
- Compact waterproof design.
- Internet access to panel data through the communication gateway (WiFi, Ethernet gateway with embedded web server). The desired real power and power factor can also be set through the communication gateway allowing dynamic control of micro grid performances and adaptation to every grid quality.
- Extremely precise MPPT algorithm.
- Very low panel's DC ripple current (50 mA).
- High efficiency.
- Integrated IPS (Interface Protection System) /Anti-Islanding Protection.
- Optional: parallel connection of two solar panels each with peak power up to 140 W and max DC input voltage up to 60 V (Double DC connector).
- Suitable for 60 and 72-cell panels up to 310 Wp.

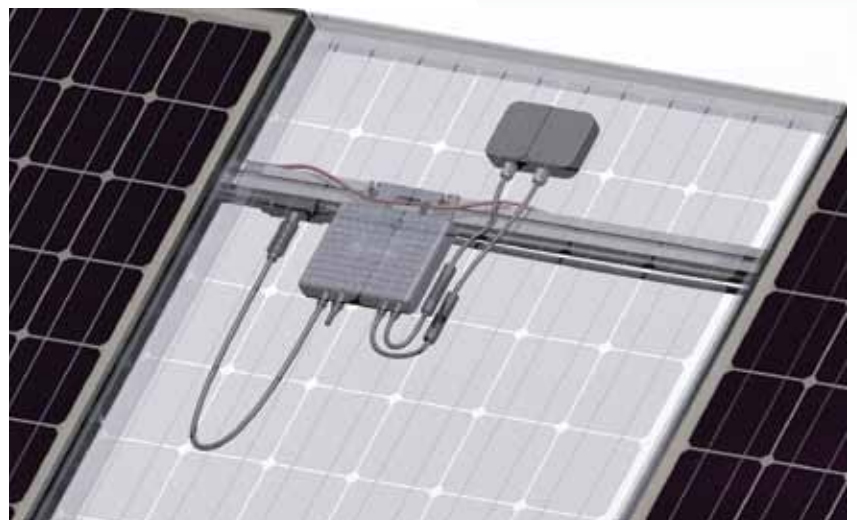



TECHNICAL CHARACTERISTICS

PARAMETERS	VALUE
Recommended rated input DC power	200 W - 275 W
Max PV panel power	up to 310 Wp
Max DC input voltage	60 V
MPPT range	21 V-55 V
Min start voltage	21 V
Max DC short circuit current	12 A
Max input current	10.5 A
Operating range	15 V- 60 V
Nominal apparent AC power	290 VA
Nominal real AC power	260 W
Nominal reactive AC power (at power factor 0.9)	125 VAR
Max reactive power	0 - 260 VAR (cap., ind.)
Nominal output current	1.15 A
Frequency range	50 Hz (47.5 Hz-55 Hz) According to standards
Voltage range 240 V systems	180 V - 270 V According to standards
Reactive power regulation	1 (Unity) 0.8 cap. ... 1 ... 0.8 ind. Dynamic regulation
THD odd harmonics	< 3 %
Efficiency max.	96.1 %
Efficiency CEC/EURO	95.5 % / 95.3 %
MPPT efficiency	99.9 %
Panel's ripple current	50 mA
Ambient temperature	-40 °C ... +65 °C
Cooling	Natural
Communication	WMBUS 868 Mhz (optional 915 Mhz)
Complies to	EN 50438, VDE 4105, CEI 0-21, G83/2, EN 62109-1, EN 62109-2, EN 61000-6-3, EN 61000-6-1, RoHS
Lifetime expectancy	25 years
Limited warranty	25 years
Housing	Die casted aluminum
IP protection	IP67, completely potted (waterproof)
Dimensions (without mounting brackets)	209 x 221 x 40 mm
Mounting brackets	M8x16, distance 130 mm
Weight	cca 2 kg
AC connection system	Amphenol LTW VTC/Wieland RST
DC connection system	Amphenol LTW H4
Standby consumption	0 W
Integrated Interface Protection System/Anti-islanding protection	as for VDE 4105

COMMUNICATION GATEWAY

The communication gateway enables simple wireless monitoring and control of each individual panel of a solar power plant from any web enabled device through an intuitive graphical interface. Three-phase grid system can be monitored and controlled with only one device.

FEATURES

- Embedded linux operating system.
- RF, 868Mhz WMBUS communication.
- Software stack complies to EN 13757-1 ... 5 and EN 870-5.
- Possibility to send special command to the micro inverters (desired power factor, desired generating power, start-stop command).
- Allows balancing of production and consumption of electricity in micro grid networks.
- Collecting, storing and retransmitting data to the service provider via Wifi, Ethernet and GSM / GPRS communications.
- Works with registered micro inverters, which are filtered by ID number.
- AES-128 encryption.
- WAN connectivity.

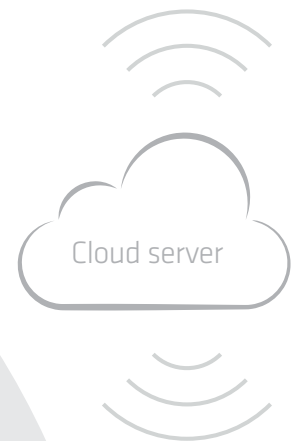

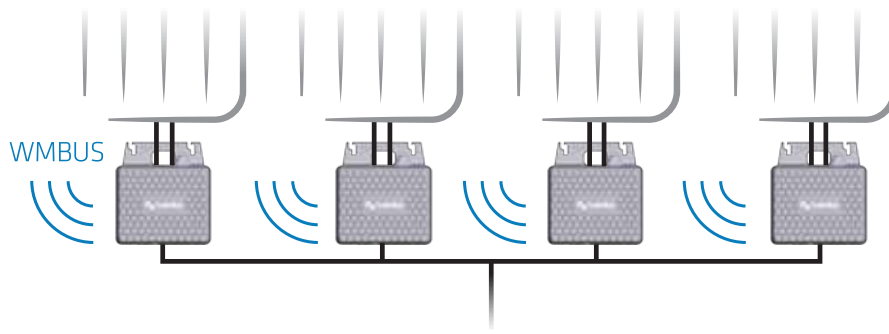

MONITORING

- Web application compatible with all platforms: PC, notebooks, smartphones, tablets.
- Generated energy on each PV panel (daily, weekly, monthly, yearly).
- Actual power from each PV panel.
- Each PV panel DC voltage and current.
- Each micro inverter AC output current and voltage.
- Efficiency of each PV panel.
- Presence of each PV panel.
- Faults on each panel.
- Internal temperature of each micro inverter.
- Wake up and sleep time of each micro inverter.

The power plant can be monitored via notebook, tablet and smartphone.

Main information:

- Overall energy
- Overall reduced CO₂ emissions
- Earned / saved money
- Current power
- Alarms

CONTROLLING

- Each micro inverter power.
- Each micro inverter power factor.
- Each micro inverter ON-OFF.

CLOUD SERVER

- Data available for external cloud server.
- Documented interface based on https protocol allows access to real time data for external cloud server.

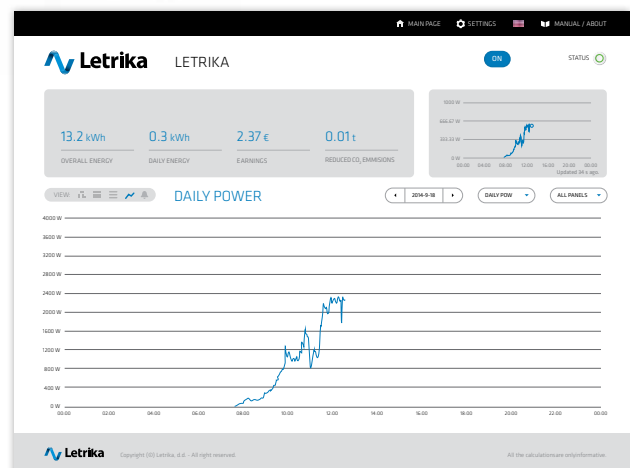
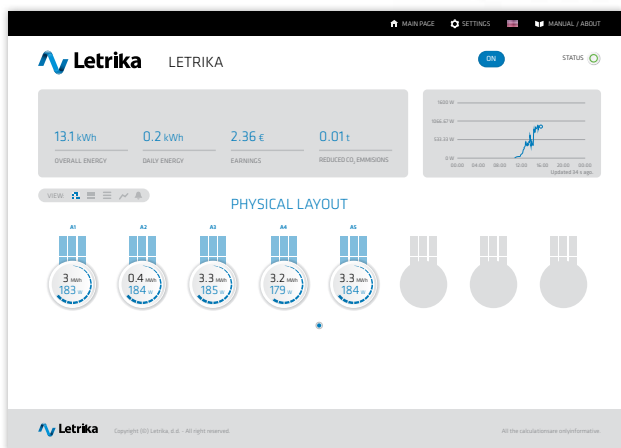
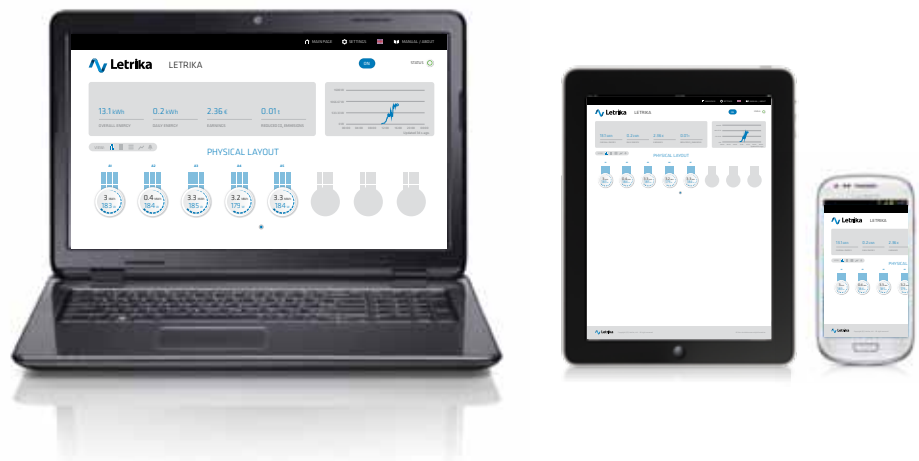

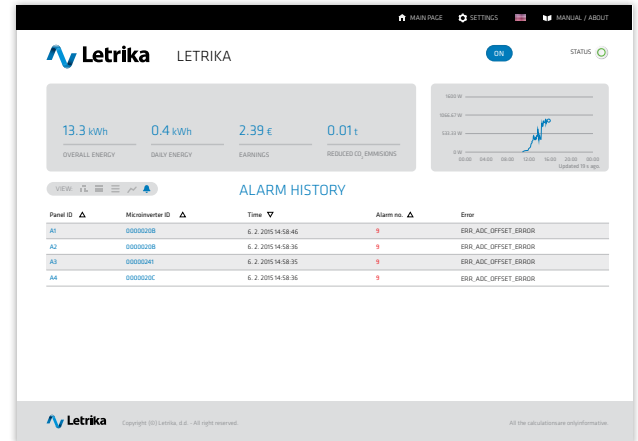
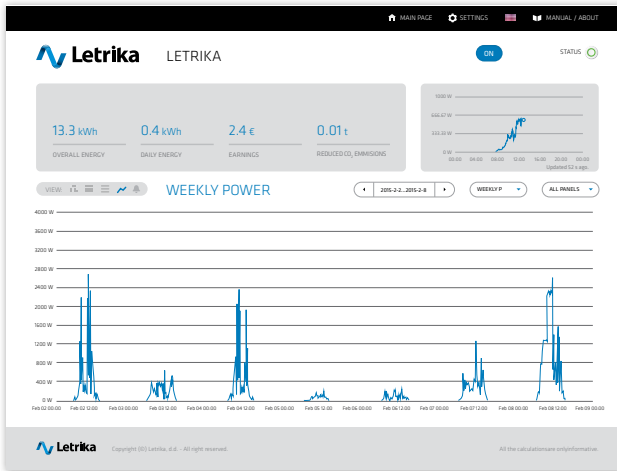

TECHNICAL CHARACTERISTICS

Communication to microinverters	WMbus 868 MHz, selectable sample rate(min 60s)
Communication to PC, tablet, smartphone	WiFi IEEE 802.11/2.4GHz, Ethernet RJ45
Connectors	1xRJ45 Ethernet, 1xUSB(for additional functions)
Operation system	Embedded Linux, Integrated web server
Data storage	SD card (Max. 32 GB)
Supply voltage	12v DC
IP protection	IP 40
Ambient temperature	-20...+55°C
Weight	350g
Dimensions	150x37x155mm
Optional sending data to cloud by predefined protocol	
Basic monitoring and settings through LCD display	
POWER SUPPLY	
Input	100...240Vac; 50Hz-60Hz
Output	12Vdc, 700mA
IP protection	IP 40
Optional	Extension cable for WMbus antenna



HEADQUARTERS

Letrika Sol d.o.o.
Vrtojbenksa cesta 64
5290 Šempeter pri Gorici, Slovenia
T: +386 5 339 4262
E: info.sol@letrika.com

Letrika Sol d.o.o. is a joint venture between companies Cosylab d.d. and Letrika d.d.

Cosylab d. d., Control System Laboratory
Teslova ulica 30
1000 Ljubljana, Slovenia

T: +386 1 477 66 76
F: +386 1 477 66 10
E: info@cosylab.com

Letrika d.d.
Polje 15
5290 Šempeter pri Gorici, Slovenia

T: +386 5 339 3000
F: +386 5 339 3801
E: info@letrika.com

